

# Optimal Design of Non-Regenerative MIMO Wireless Relays

Xiaojun Tang and Yingbo Hua, *Fellow, IEEE*

**Abstract**—Given a multiple-antenna source and a multiple-antenna destination, a multiple-antenna relay between the source and the destination is desirable under useful circumstances. A non-regenerative multiple-antenna relay, also called non-regenerative MIMO (multi-input multi-output) relay, is designed to optimize the capacity between the source and the destination. Without a direct link between the source and the destination, the optimal canonical coordinates of the relay matrix are first established, and the optimal power allocations along these coordinates are then found. The system capacity with the optimal relay matrix is shown to be significantly higher than those with heuristic relay matrices. When a direct link is present, upper and lower bounds of the optimal system capacity are discussed.

**Index Terms**—Multiple-antenna relay, MIMO relay, non-regenerative relay, capacity analysis, optimal canonical coordinates, optimal power allocation.

## I. INTRODUCTION

WIRELESS relaying is essential to provide reliable transmission, high throughput and broad coverage for wireless networks in a variety of applications. In a cellular environment, a relay can be deployed in areas where there are strong shadowing effects, such as inside buildings and tunnels. For mobile ad hoc networks, relaying is essential not only to overcome shadowing due to obstacles but also to reduce unnecessary transmission power from source and hence radio frequency interference to neighboring nodes. For tactical applications, dynamic deployment of manned or unmanned relays are useful to enhance the network's reliability, throughput and low probability of detection and/or interception.

A three-terminal relay channel model was studied in 1970's as in [1] and [2]. More recent activities on relays are shown in [3], [4], [5], [6] and [7]. Systems of single-antenna relays have been a primary focus of prior research.

It is now well known that a multiple-antenna system can provide higher rate data transmission than a single-antenna system in a scattered environment. The capacity of single-user point-to-point multiple-input and multiple-output (MIMO) channel was well studied in [8] and [9]. Research of MIMO relays is recently shown in [10] where a regenerative MIMO

relay is considered. A regenerative relay regenerates the original information from the previous node before it retransmits the information to the next node. In [10], it is also assumed that the relay receives and transmits signals simultaneously at a common frequency. While theoretically possible, this is a practically unstable approach because the power of the transmitted signal at the relay typically overshadows the power of the desired signal at the relay. Currently, there is no technology that allows a relay to work in the above mode. The relay to be considered in this paper uses two orthogonal channels for reception and transmission.

While there is a natural need for regenerative relays for which a decode-and-forward scheme (DF) is needed, there is also a need for non-regenerative relays for which only an amplify-and-forward scheme (AF) is required. Comparisons of the performances of the DF and AF schemes for single-antenna relay systems are recently shown in [11] and [5]. It has been observed that the AF scheme can achieve a better diversity order with the same multiplexing gain than the DF scheme although the two schemes may outperform each other in terms of the ergodic capacity depending on channel realizations.

In this paper, we study a non-regenerative MIMO relay system where the information data are not regenerated at the relay except that the baseband symbols are reproduced. We believe that a non-regenerative MIMO relay has the following potential advantages over a regenerative MIMO relay. First, a non-regenerative relay can relay signals faster than a regenerative relay if two frequency channels are used for the relay's input and output, respectively. Second, deployment of a non-regenerative relay could have little effect on the operations at the source and the destination as there is no handshaking requirement for each packet going through the non-regenerative relay using two frequency channels. Third, a non-regenerative relay contains virtually no information for decoding the source and hence exposes no security information even if it is stolen by enemy. These potential advantages could make (especially, two-hop) non-regenerative relays readily useful within a given wireless infrastructure and/or mobile ad hoc networks.

Our main contribution in this paper is the development of the optimal non-regenerative MIMO relay matrix that maximizes the capacity between the source and the destination when a direct link is not considered or is negligible. It is shown that the weighting matrix applied at the optimal MIMO relay obeys an optimal set of canonical coordinates governed by the channel matrices in the system. The optimal set of canonical coordinates decompose the MIMO relay channel into several parallel single-input and single-output (SISO) sub-channels.

Manuscript submitted July 21, 2005; revised January 9, 2006 and January 11, 2006; accepted January 11, 2006. The associate editor coordinating the review of this letter and approving it for publication was J. Zhang. The work was supported in part by the U. S. National Science Foundation under Grant No. ECS-0401310, the U. S. Army Research Laboratory under the CTA Program Cooperative Agreement DAAD19-01-2-0011, and the U. S. Army Research Office under the MURI Grant No. W911NF-04-1-0224.

X. Tang is with the Wireless Information Network Laboratory, Rutgers University, New Brunswick, NJ, 08854 (email: datang@eden.rutgers.edu).

Y. Hua is with the Department of Electrical Engineering, University of California, Riverside, CA 92521, USA (email: yhua@ee.ucr.edu).

Digital Object Identifier 10.1109/TWC.2007.05527.

(We use the term “relay channel” more broadly than some people are accustomed to.) It is also shown that a water-filling like algorithm can be used to optimize the power allocation along these coordinates (or sub-channels). The result in this paper extends our earlier work in [12] to the case where there could be unequal numbers of antennas, the channel matrices could be singular, and signal to noise ratio at the destination node could be arbitrary. We also give an upper bound and two lower bounds on the optimal capacity of the MIMO relay channel when a direct link between the source and the destination is present.

It is clear that a relay is much more important when the direct link is weak than when the direct link is strong. In the former case, the contribution by the direct link can be negligible (as supported by results shown later in Figure 8).

We acknowledge an independent work shown in [13] where a similar result is reported. Comparing to the development given in [13], our proof of the optimal coordinates is much more rigorous.

Throughout this paper, we will use the following conventions.  $\dagger$  denotes the conjugate transpose.  $\mathcal{E}$  denotes the expectation operator with subscripts specifying related random variables.  $I_M$  denotes an  $M \times M$  identity matrix.  $O$  is an all-zero matrix with the dimension identified by the context. A circularly symmetric complex Gaussian vector with mean  $\mu$  and covariance matrix  $\Sigma$  will be denoted as  $\mathcal{CN}(\mu, \Sigma)$ .

The rest of the paper is organized as follows. In Section II, we introduce the system model of orthogonal MIMO relay channel and then formulate the problem of optimal non-regenerative MIMO relay. The optimal canonical coordinates of the optimal MIMO relay matrix, when the direct link is not considered, are given and proved in section III. The optimal power allocation along the optimal coordinates is developed in section IV. Numerical illustrations of the optimal capacity of the MIMO relay system without a direct link are presented in section V. In Section VI, we study the case where there is a direct link, and we show an upper bound and two lower bounds on the optimal capacity. Section VII concludes the paper.

## II. SYSTEM MODEL AND PROBLEM FORMULATION

Consider a three-terminal orthogonal MIMO relay channel as shown in Figure 1, where a relay is used to assist the transmission from source to destination. All terminals in the relay model are equipped with multiple antennas.

The source transmits (broadcasts) to the relay and destination in channel 1 (solid line), and the relay transmits to the destination in channel 2 (dashed line). Channels 1 and 2 are orthogonal to each other. In practice, the two channels should be further divided in time or frequency as a relay cannot receive and transmit at the same time in the same frequency band. For fast data transmission and convenient implementation, division in frequency appears more advantageous than division in time.

As long as the channel coherence time is larger than the reciprocal of the channel coherence bandwidth, all fading channels may be modelled as if they were frequency flat, through use of multiple narrow-band carriers (such as orthogonal frequency division multiplexing). This is the case

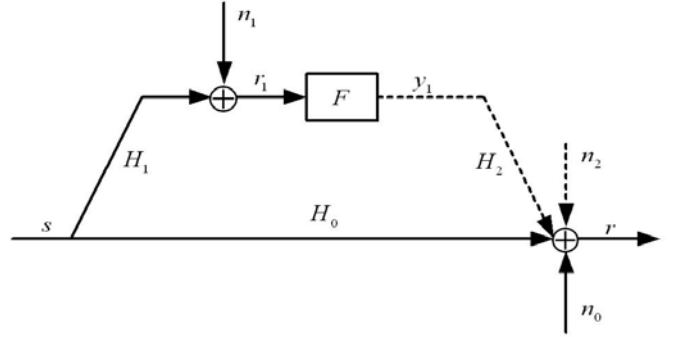

Fig. 1. A three-terminal orthogonal MIMO relay channel model, channel 1 (broadcast channel, solid lines) is orthogonal to channel 2 (relay-destination channel, dashed lines). At the destination, the signal  $r$  may contain components from channel 1 and channel 2.

for most practical environments. Therefore, we will assume that the MIMO channel responses between the source and the relay, the relay and the destination, and the source and the destination, are represented, respectively, by constant (as opposed to polynomial) matrices  $H_1$ ,  $H_2$ , and  $H_0$ . The transfer function of a non-regenerative relay is equivalent to a memoryless weighting matrix  $F$  that transforms the (baseband) waveform received at the relay to the (baseband) waveform transmitted from the relay. Furthermore, we assume that during the transmission of each packet of data,  $H_0$ ,  $H_1$ ,  $H_2$  and  $F$  remain constant (as opposed to time varying). The numbers of antennas equipped at the source, destination and relay are denoted as  $M$ ,  $N$  and  $L$ , respectively, and thus we can write  $H_0 \in \mathcal{C}^{N \times M}$ ,  $H_1 \in \mathcal{C}^{L \times M}$ ,  $H_2 \in \mathcal{C}^{N \times L}$  and  $F \in \mathcal{C}^{L \times L}$ . There is little need to consider a non-square  $F$  since all  $L$  antennas at the relay can be used for both receiving and transmitting.

There are three basic modes for the three-terminal MIMO relay system:

(A) Direct Link Without Relay: The signal received at the destination is

$$r = H_0 s + n_0 \quad (1)$$

where  $s$  is assumed to be a  $M \times 1$  zero mean circularly symmetric complex Gaussian signal transmitted by the source terminal. Also assume that the source works in spatial multiplexing mode, i.e., the source transmits independent data streams from different antennas and over different sub-carriers. So, we have  $E\{ss^\dagger\} = \frac{P_1}{M} I_M$ , where  $P_1$  is the transmission power used by the source. The superscript  $\dagger$  denotes complex conjugation. We can write  $s \sim \mathcal{CN}(0, \frac{P_1}{M} I_M)$ . The noise is also complex circular white Gaussian, i.e.,  $n_0 \sim \mathcal{CN}(0, \sigma_0^2 I_N)$ . Assume that the source does not know or use the channel state information (CSI) but the destination knows and uses the CSI. Then, the “instantaneous” (i.e., corresponding to a packet duration) capacity between the source and the destination is given by [8],

$$C_{I,A} = \log_2 \left| I_M + \rho_0 H_0^\dagger H_0 \right| \quad (2)$$

where  $|\cdot|$  represents the determinant of a matrix; and  $\rho_0 = \frac{P_1}{M\sigma_0^2}$  is the (normalized) signal to noise ratio (SNR) at the destination terminal in channel 1.

(B) Relay Without Direct Link: The signal received at the destination is

$$r = H_2 F H_1 s + H_2 F n_1 + n_2 \quad (3)$$

where  $n_1 \sim \mathcal{CN}(0, \sigma_1^2 I_L)$  and  $n_2 \sim \mathcal{CN}(0, \sigma_2^2 I_N)$ . Let  $R$  denote the covariance matrix of the (total) noise term in (3). We have

$$R = \sigma_2^2 (I_N + \frac{\sigma_1^2}{\sigma_2^2} H_2 F F^\dagger H_2^\dagger) \quad (4)$$

As shown in Appendix I, the instantaneous capacity between the source and the destination in this case is

$$C_{I,B} = \log_2 \left| I_L + \rho_1 H_1 H_1^\dagger - \rho_1 H_1 H_1^\dagger S^{-1} \right| \quad (5)$$

with  $\rho_1 = \frac{P_1}{M\sigma_1^2}$  which is the (normalized) SNR at the relay, and

$$S = I_L + \frac{\sigma_1^2}{\sigma_2^2} F^\dagger H_2^\dagger H_2 F. \quad (6)$$

(C) Relay With Direct Link: The signals received at the destination in two orthogonal channels can be expressed as the following vector:

$$r = \begin{bmatrix} r_1 \\ r_2 \end{bmatrix} = \begin{bmatrix} H_0 \\ H_2 F H_1 \end{bmatrix} s + \begin{bmatrix} n_0 \\ H_2 F n_1 + n_2 \end{bmatrix} \quad (7)$$

The instantaneous capacity between the source and the destination is now given by (see Appendix II)

$$C_{I,C} = \log_2 \left| I_M + \rho_0 H_0^\dagger H_0 + \rho_1 H_1^\dagger H_1 - \rho_1 H_1^\dagger S^{-1} H_1 \right| \quad (8)$$

or equivalently,

$$C_{I,C} = \log_2 \left| I_M + \rho_0 H_0^\dagger H_0 \right| + \log_2 \left| I_L + \rho_1 H_3 H_3^\dagger - \rho_1 H_3 H_3^\dagger S^{-1} \right| \quad (9)$$

where

$$H_3 = H_1 \left( I_M + \rho_0 H_0^\dagger H_0 \right)^{-1/2} \quad (10)$$

Comparing (9) with (2) and (5), we can see that the system working in mode C can be decomposed into two virtually parallel systems working in modes A and B respectively.

We will establish the optimal relay matrix  $F$  that maximizes  $C_{I,B}$  in the next two sections. The optimal  $F$  that maximizes  $C_{I,C}$  is still unknown. But we will discuss upper and lower bounds on the optimal  $C_{I,C}$  in a later section.

We will assume that the average power used by the source is upper bounded by  $P_1$ , and the average power used by the relay is upper bounded by  $P_2$ . Since the transmitted signal from the relay is  $F H_1 s + F n_1$ , the power constraint on the relay leads to the following constraint on  $F$ :

$$\sigma_1^2 \text{tr}\{F(I_L + \rho_1 H_1 H_1^\dagger)F^\dagger\} \leq P_2 \quad (11)$$

where  $\text{tr}\{\cdot\}$  represents the trace of a matrix. For convenience, we will use

$$G = \frac{\sigma_1}{\sigma_2} F. \quad (12)$$

Using (12) in (5), (6) and (11), we have the following optimization problem for the MIMO relaying system working in mode B:

$$\max C_{I,B} = \log_2 \left| I_L + \rho_1 H_1 H_1^\dagger - \rho_1 H_1 H_1^\dagger S^{-1} \right| \quad (13)$$

$$s.t. \quad \text{tr}\{G(I_L + \rho_1 H_1 H_1^\dagger)G^\dagger\} \leq \rho_2 L \quad (14)$$

where  $S = I_L + G^\dagger H_2^\dagger H_2 G$ , and  $\rho_2 = \frac{P_2}{L\sigma_2^2}$  which is the (normalized) SNR at the destination in channel 2.

If the relay does not know the CSI (i.e.,  $H_1$  and  $H_2$ ), the relay matrix  $F$  (or  $G$ ) may be chosen by maximizing the ergodic capacity  $C_{e,B} = \mathcal{E}_{H_1, H_2}\{C_{I,B}\}$  with the average power constraint  $\mathcal{E}_{H_1}\{\text{tr}\{G(I_L + \rho_1 H_1 H_1^\dagger)G^\dagger\}\} \leq \rho_2 L$ . It is easy to show that the maximal ergodic capacity with unknown CSI at the relay can be achieved by using a diagonal weighting matrix. Suppose that  $G$  is optimal and has the singular value decomposition  $G = U_G \Sigma_G V_G$  where  $U_G$  and  $V_G$  are unitary and  $\Sigma_G$  is diagonal. We now form an equivalent system by replacing  $H_1$  by  $\tilde{H}_1 = V_G H_1$ ,  $H_2$  by  $\tilde{H}_2 = H_2 U_G$ , and  $G$  by  $\tilde{G} = \Sigma_G$ . Under the assumption that all elements of  $H_1$  and  $H_2$  are *i.i.d.* Gaussian,  $\tilde{H}_1$  and  $\tilde{H}_2$  have the same statistical distributions as  $H_1$  and  $H_2$  respectively. Hence, the maximum ergodic capacity of the system is not changed if  $\tilde{H}_1$  and  $\tilde{H}_2$  are changed back to  $H_1$  and  $H_2$  and  $\Sigma_G$  remains the same. Namely,  $G$  and  $\Sigma_G$  are equally optimal.

In the rest of this paper, we assume that the relay knows both  $H_1$  and  $H_2$  in mode B and, in addition,  $H_0$  in mode C. We will find the optimal  $F$  to maximize the instantaneous capacity  $C_{I,B}$ .

### III. OPTIMAL CANONICAL COORDINATES

Let the eigenvalue decompositions of  $H_1 H_1^\dagger$  and  $H_2^\dagger H_2$  be

$$H_1 H_1^\dagger = U_1 \Sigma_1 U_1^\dagger \quad (15)$$

$$H_2^\dagger H_2 = V_2 \Sigma_2 V_2^\dagger \quad (16)$$

where  $U_1$  and  $V_2$  are unitary matrices,  $\Sigma_1 = \text{diag}\{\alpha_1, \alpha_2, \dots, \alpha_L\}$  with  $\alpha_l \geq 0$ , and  $\Sigma_2 = \text{diag}\{\beta_1, \beta_2, \dots, \beta_L\}$  with  $\beta_l \geq 0$ . Our convention is that all eigenvalues are arranged in the descending order.

We will show that the optimal relay matrix is given by

$$F = V_2 \Lambda_F U_1^\dagger \quad (17)$$

where  $\Lambda_F$  is a diagonal matrix. Hence,  $F$  can be considered as a matched filter along the singular vectors of the channel matrices. The result of (17) was previously given in [12] assuming nonsingular  $H_1$  and  $H_2$  and a large enough  $\rho_2$ . In the following, we prove that the structure of (17) is actually optimal for any  $H_1$  and  $H_2$  and any  $\rho_2 > 0$ .

Referring to (13), we first write

$$\left| I_L + \rho_1 H_1 H_1^\dagger - \rho_1 H_1 H_1^\dagger Q^{-1} \right| = \frac{|I + (I + \rho_1 H_1 H_1^\dagger)G^\dagger H_2^\dagger H_2 G|}{|I + G^\dagger H_2^\dagger H_2 G|} \quad (18)$$

Without loss of any generality, let

$$G = V_2 X (I + \rho_1 \Sigma_1)^{-1/2} U_1^\dagger \quad (19)$$

where  $X$  may be any matrix. Using (19) in (13) and (18), the channel capacity expression becomes

$$C_{I,B} = \log_2 |I + \rho_1 \Sigma_1| + \log_2 \frac{|I + X^\dagger \Sigma_2 X|}{|I + \rho_1 \Sigma_1 + X^\dagger \Sigma_2 X|} \quad (20)$$

which is easy to verify by using  $|I + AB| = |I + BA|$ . It is interesting to note that the first term on the right hand side of

(20) is the capacity of the channel from the source to the relay. We can think of the second term as a capacity loss (since it is always non-positive) due to the second hop. Our objective is to design a weighting matrix  $F$  to minimize this capacity loss. Since the first term is a constant, the optimization problem (13) is equivalent to the following problem:

$$\begin{aligned} \max \quad & J(X) = \frac{|I + X^\dagger \Sigma_2 X|}{|I + \rho_1 \Sigma_1 + X^\dagger \Sigma_2 X|} \\ \text{s.t.} \quad & \text{tr}\{X X^\dagger\} \leq \rho_2 L \end{aligned} \quad (21)$$

We will need the following two matrix inequalities [14]: Given two  $N \times N$  positive semidefinite Hermitian matrices  $A$  and  $B$  with eigenvalues  $\lambda_k(A)$  and  $\lambda_k(B)$  arranged in the descending order respectively, then

$$\prod_{k=1}^N (\lambda_k(A) + \lambda_k(B)) \leq |A + B| \leq \prod_{k=1}^N (\lambda_k(A) + \lambda_{N+1-k}(B)) \quad (22)$$

$$\sum_{k=1}^N \lambda_k(A) \lambda_{N+1-k}(B) \leq \text{tr}(AB) \leq \sum_{k=1}^N \lambda_k(A) \lambda_k(B) \quad (23)$$

Now, we prove that a diagonal matrix  $X$  can maximize  $J(X)$ . Given any matrix  $X$ ,  $T := X^\dagger \Sigma_2 X$  is positive semidefinite. Let the eigenvalue decomposition of  $T$  be

$$T := X^\dagger \Sigma_2 X = U_T \Sigma_T U_T^\dagger \quad (24)$$

For any matrix  $X$ , we can always find another matrix  $\tilde{X} = X U_T$ , such that  $\tilde{X}^\dagger \Sigma_2 \tilde{X} = \Sigma_T$  and

$$J(\tilde{X}) = \frac{|I + \Sigma_T|}{|I + \rho_1 \Sigma_1 + \Sigma_T|} \geq \frac{|I + U_T \Sigma_T U_T^\dagger|}{|I + \rho_1 \Sigma_1 + U_T \Sigma_T U_T^\dagger|} = J(X)$$

$$\text{tr}\{X X^\dagger\} = \text{tr}\{\tilde{X} \tilde{X}^\dagger\}$$

where we applied (22), i.e.

$$\begin{aligned} |I + \Sigma_T| &= |I + U_T \Sigma_T U_T^\dagger| \\ |I + \rho_1 \Sigma_1 + \Sigma_T| &\leq |I + \rho_1 \Sigma_1 + U_T \Sigma_T U_T^\dagger| \end{aligned} \quad (25)$$

The equality in (25) is achieved when  $U_T = I$ .

We can see that the optimum  $X$  must diagonalize  $X^\dagger \Sigma_2 X$ , i.e., the optimal  $X$  can be written as

$$X^\dagger \Sigma_2 X = \Sigma_T \quad (26)$$

where  $\Sigma_T$  is a diagonal matrix with nonnegative diagonal entries, and  $\text{rank}(\Sigma_T) \leq \text{rank}(\Sigma_2) = l \leq \min(L, N)$ . We can partition  $\Sigma_2$ ,  $X$  and  $\Sigma_T$  properly so that (26) becomes

$$\begin{pmatrix} X_1^\dagger & X_2^\dagger \end{pmatrix} \begin{pmatrix} \tilde{\Sigma}_2 & O \\ O & O \end{pmatrix} \begin{pmatrix} X_1 \\ X_2 \end{pmatrix} = \begin{pmatrix} \tilde{\Sigma}_T & O \\ O & O \end{pmatrix} \quad (27)$$

where  $\tilde{\Sigma}_2$  and  $\tilde{\Sigma}_T$  are both  $l \times l$  diagonal matrices,  $\tilde{\Sigma}_2$  is of full rank, but  $\tilde{\Sigma}_T$  is not yet necessarily of full rank.

From (27), we have

$$X = \begin{pmatrix} X_1 \\ X_2 \end{pmatrix} = \begin{pmatrix} \tilde{\Sigma}_2^{-1/2} Q \Sigma_T^{1/2} \\ X_2 \end{pmatrix} \quad (28)$$

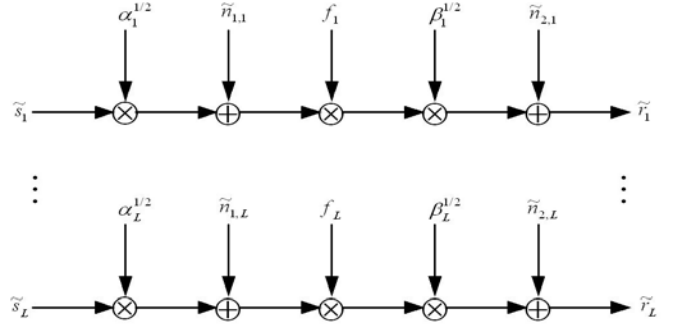

Fig. 2. The optimal canonical coordinates decompose the original MIMO channel into parallel SISO subchannels

where  $Q$  is an  $l \times l$  orthogonal matrix, and  $\Sigma_T^{1/2}$  is an  $l \times L$  matrix with

$$\Sigma_T^{1/2} = \begin{pmatrix} \tilde{\Sigma}_T^{1/2} & O \end{pmatrix}$$

We now examine the power constraint on  $X$ . The optimal  $X$  should not only satisfy (27) but also minimizes the power  $\text{tr}\{X X^\dagger\}$ . Under (28), we have

$$\text{tr}\{X X^\dagger\} = \text{tr}\{X^\dagger X\} = \text{tr}\{X_1^\dagger X_1\} + \text{tr}\{X_2^\dagger X_2\} \quad (29)$$

where  $\text{tr}\{X_2^\dagger X_2\} \geq 0$  with equality when  $X_2 = O$ , and

$$\text{tr}\{X_1^\dagger X_1\} = \text{tr}\{\Sigma_T^{\dagger/2} Q^\dagger \tilde{\Sigma}_2^{-1} Q \Sigma_T^{1/2}\} = \text{tr}\{\tilde{\Sigma}_T Q^\dagger \tilde{\Sigma}_2^{-1} Q\}$$

By (23), we have

$$\text{tr}\{\tilde{\Sigma}_T Q^\dagger \tilde{\Sigma}_2^{-1} Q\} \geq \text{tr}\{\tilde{\Sigma}_T \tilde{\Sigma}_2^{-1}\}$$

where the equality holds when  $Q = I$ . Therefore, the optimal  $X$  should be in the form of

$$X = \begin{pmatrix} \tilde{\Sigma}_2^{-1/2} \tilde{\Sigma}_T^{1/2} & O \\ O & O \end{pmatrix}. \quad (30)$$

In summary, given an arbitrary matrix  $X$ , we can always find a new  $X$  in the form given by (30), which yields better performance with the average power constraint satisfied. Since the new  $X$  is always a diagonal matrix, we conclude that the optimal structure of  $X$  should be diagonal. Combining (30), (12) and (19), we can see that (17) indeed gives the optimal canonical coordinates for the weighting matrix  $F$ .

#### IV. POWER ALLOCATION ALONG CANONICAL COORDINATES

When the weighting matrix  $F$  obeys a set of canonical coordinates given by (17), the MIMO relay channel is decomposed into several parallel SISO channels as shown in Figure 2. For example, if we substitute (17) into (3), then the signal received at the destination is

$$\tilde{r} = \Lambda_2 \Lambda_F \Lambda_1 \tilde{s} + \Lambda_2 \Lambda_F \tilde{n}_1 + \tilde{n}_2 \quad (31)$$

where we used the singular value decompositions (SVD):  $H_1 = U_1 \Lambda_1 V_1^\dagger$  and  $H_2 = U_2 \Lambda_2 V_2^\dagger$ . Also,  $\tilde{s} = U_1^\dagger s$ ,  $\tilde{r} = U_2^\dagger r$ ,  $\tilde{n}_1 = U_1^\dagger n_1$ ,  $\tilde{n}_2 = U_2^\dagger n_2$ . Note that the unitary matrices  $U_1$  and  $U_2$  do not change the statistics of  $s$ ,  $r$ ,  $n_1$  or  $n_2$  under the white Gaussian assumption.

Since the MIMO channel is decomposed into (orthogonal) parallel SISO sub-channels, the problem now is how to

allocate the total power to those sub-channels. Without loss of generality, we let

$$\Lambda_F = \frac{\sigma_2}{\sigma_1} \Lambda_X (I_L + \rho_1 \Sigma_1)^{-1/2} \quad (32)$$

where  $\Lambda_X$  is a diagonal matrix that we need to optimize. Denote  $\Sigma_X = \Lambda_X^2 = \text{diag}\{x_1, x_2, \dots, x_L\}$ . The average power constraint of (14) becomes

$$\sum_{k=1}^L x_k \leq \rho_2 L \quad (33)$$

The instantaneous channel capacity  $C_{I,B}$  under the optimal coordinates is now rewritten as

$$f(x) = \sum_{k=1}^L \log_2(1 + \rho_1 \alpha_k) + \sum_{k=1}^L \log_2 \left( \frac{1 + \beta_k x_k}{1 + \rho_1 \alpha_k + \beta_k x_k} \right) \quad (34)$$

where  $\{\alpha_k\}$  and  $\{\beta_k\}$  are eigenvalues of  $H_1 H_1^\dagger$  and  $H_2^\dagger H_2$  arranged in the descending order. The first term is a constant and hence we only need to maximize the second term. Although  $f(x)$  is nonlinear, it is easy to check that  $\nabla^2 f(x)$ , the Hessian of  $f(x)$ , is negative definite, i.e.  $\nabla^2 f(x) \prec 0$ . In other words,  $f(x)$  is concave. Because the constraint is convex, the problem is easily transformed into a standard convex optimization problem:

$$\begin{aligned} \min \quad & J_0 = - \sum_{k=1}^L \log_2 \left( \frac{1 + \beta_k x_k}{1 + \rho_1 \alpha_k + \beta_k x_k} \right) \quad (35) \\ \text{s.t.} \quad & \sum_{k=1}^L x_k - \rho_2 L \leq 0 \quad \text{and} \quad -x_k \leq 0 \end{aligned}$$

The associated Lagrangian is

$$J = J_0 + \nu \left( \sum_{k=1}^L x_k - \rho_2 L \right) - \sum_{k=1}^L \lambda_k x_k \quad (36)$$

with the following Karush-Kuhn-Tucker (KKT) conditions [15]:

$$\sum_{k=1}^L x_k - \rho_2 L \leq 0 \quad (37)$$

$$-x_k \leq 0 \quad (38)$$

$$\nu \geq 0 \quad (39)$$

$$\lambda_k \geq 0 \quad (40)$$

$$\nu \left( \sum_{k=1}^L x_k - \rho_2 L \right) = 0 \quad (41)$$

$$\lambda_k x_k = 0 \quad (42)$$

$$- \left( \frac{\beta_k}{1 + \beta_k x_k} - \frac{\beta_k}{1 + \rho_1 \alpha_k + \beta_k x_k} \right) + \nu - \lambda_k = 0 \quad (43)$$

Combining (40) and (43) gives

$$\nu \geq \frac{\frac{\rho_1 \alpha_k}{\beta_k}}{\left( x_k + \frac{1}{\beta_k} \right) \left( x_k + \frac{1 + \rho_1 \alpha_k}{\beta_k} \right)} \quad (44)$$

Substituting (43) into (42) yields

$$x_k \left( \nu - \left( \frac{\frac{\rho_1 \alpha_k}{\beta_k}}{\left( x_k + \frac{1}{\beta_k} \right) \left( x_k + \frac{1 + \rho_1 \alpha_k}{\beta_k} \right)} \right) \right) = 0 \quad (45)$$

In order to satisfy (45), it is easy to prove that (a) if  $\nu \geq \frac{\rho_1 \alpha_k \beta_k}{1 + \rho_1 \alpha_k}$ , then  $x_k = 0$ ; and (b) if  $\nu < \frac{\rho_1 \alpha_k \beta_k}{1 + \rho_1 \alpha_k}$ , then  $x_k > 0$  and  $\nu = \frac{\frac{\rho_1 \alpha_k}{\beta_k}}{\left( x_k + \frac{1}{\beta_k} \right) \left( x_k + \frac{1 + \rho_1 \alpha_k}{\beta_k} \right)}$ . In the case (b),  $\nu \neq 0$  and

$$x_k^2 + \frac{1}{\beta_k} (\rho_1 \alpha_k + 2) x_k + \frac{1}{\beta_k} \left( \frac{1 + \rho_1 \alpha_k}{\beta_k} - \frac{\rho_1 \alpha_k}{\nu} \right) = 0 \quad (46)$$

The solution to (46) under (38) is unique:

$$x_k = \frac{1}{2\beta_k} \left( \sqrt{\rho_1^2 \alpha_k^2 + \frac{4\rho_1 \alpha_k \beta_k}{\nu}} - \rho_1 \alpha_k - 2 \right) \quad (47)$$

Since the power allocation given by (47) will be positive if and only if  $\nu < \frac{\rho_1 \alpha_k \beta_k}{1 + \rho_1 \alpha_k}$ , we have the following unified result for  $x_k$ :

$$x_k = \frac{1}{2\beta_k} \left[ \sqrt{\rho_1^2 \alpha_k^2 + 4\rho_1 \alpha_k \beta_k \mu} - \rho_1 \alpha_k - 2 \right]^+ \quad (48)$$

where  $[y]^+ = \max(0, y)$  and  $\mu = \frac{1}{\nu}$  should be chosen to meet (41).

The allocation scheme given by (48) is similar to the well-known water-filling method. The water-filling method is used to optimally allocate power to parallel orthogonal gaussian channels [16]. In MIMO relaying, since the optimal weighting matrix decomposes the MIMO channel into several parallel orthogonal channels, it is natural that the power allocation scheme is similar to the water-filling method.

Since  $\nu \neq 0$ , from (41), there exists a unique  $\mu$  to meet  $\sum_{k=1}^L x_k = \rho_2 L$ . We define a function  $g(\mu)$ ,

$$g(\mu) = \frac{1}{2} \sum_{k=1}^L \frac{1}{\beta_k} \left[ \sqrt{\rho_1^2 \alpha_k^2 + 4\rho_1 \alpha_k \beta_k \mu} - \rho_1 \alpha_k - 2 \right]^+ - \rho_2 L \quad (49)$$

We can see that  $g(\mu)$  is a piece-wise uniformly square-rooted increasing function of  $\mu$ , with breakpoints at  $\mu = \frac{1 + \rho_1 \alpha_k}{\rho_1 \alpha_k \beta_k}$ . Meanwhile, we know that  $g(0) = -\rho_2 L < 0$  and  $g(+\infty) = +\infty$ , so  $g(\mu) = 0$  has a unique positive root  $\mu^*$ , which can be solved by many root-finding algorithms, such as Bisection etc. Note that the Newton's method may fail due to those L breakpoints.

In summary, the optimal weighting matrix of the MIMO relay in mode B is given by  $F = V_2 \Lambda_F U_1^\dagger$ , where  $\Lambda_F = \text{diag}\{f_1, f_2, \dots, f_L\}$ , and for all  $1 \leq k \leq L$ ,

$$f_k = \frac{\sigma_2}{\sigma_1} \sqrt{\frac{1}{2\beta_k(1 + \rho_1 \alpha_k)} \left[ \sqrt{\rho_1^2 \alpha_k^2 + 4\rho_1 \alpha_k \beta_k \mu^*} - \rho_1 \alpha_k - 2 \right]^+} \quad (50)$$

In addition,  $\mu^*$  is a unique root of (49), which can be solved by using a numerical root-finding algorithm.

As for the complexity of the algorithm, computations are mainly consumed in the singular value decompositions of channel matrices. The complexity of root-finding is quite low.

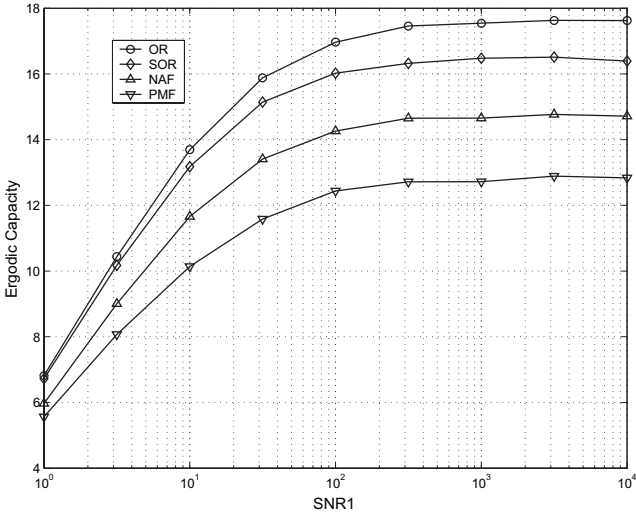

Fig. 3. Ergodic capacity  $E\{C_{I,B}\}$  as a function of  $\rho_1$  (labelled as SNR1 - the SNR at the relay).  $M = N = L = 4$ ,  $\rho_2 = 10dB$ .

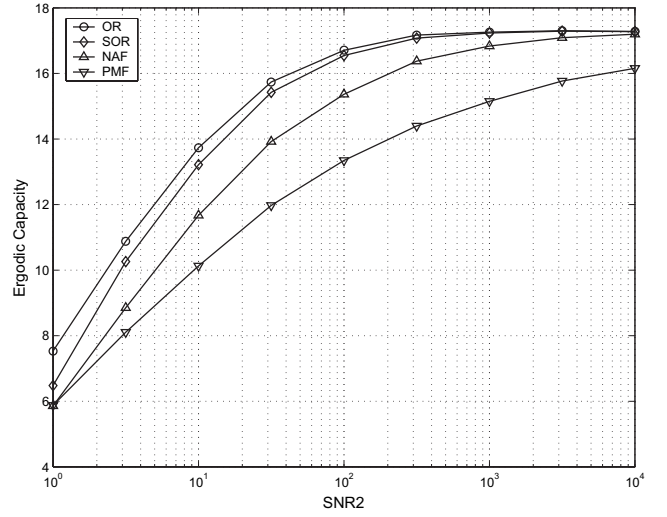

Fig. 4. Ergodic capacity  $E\{C_{I,B}\}$  as a function of  $\rho_2$  (labelled as SNR2 - the SNR at the destination).  $M = N = L = 4$ ,  $\rho_1 = 10dB$ .

## V. CAPACITY OF MIMO RELAY CHANNEL WITHOUT DIRECT LINK

In this section, we compare the optimal relaying (OR) scheme shown in the previous sections, with a few other alternative non-regenerative relaying schemes in terms of the ergodic capacity and Cumulative Distribution Function (CDF) of instantaneous capacity of the MIMO relaying channel. These alternative schemes are:

(1) Naive Amplify-and-Forward (NAF): One relaying scheme could simply normalize the received signal to meet the power constraint and then forward the signal to the destination. In this case, the weighting matrix at the relay is

$$F_{naf} = \eta_1 I_L \quad (51)$$

The power constraint is given by (11), and hence

$$\eta_1 = \frac{\sigma_2}{\sigma_1} \sqrt{\frac{\rho_2 L}{\text{tr}\{I_L + \rho_1 H_1 H_1^\dagger\}}} \quad (52)$$

(2) Pseudo Match-and-Forward (PMF): Another simple choice of the weighting matrix at the relay as used in [17] is

$$F_{pmf} = \eta_2 H_2^\dagger H_1^\dagger \quad (53)$$

To meet the power constraint,  $\eta_2$  is given by

$$\eta_2 = \frac{\sigma_2}{\sigma_1} \sqrt{\frac{\rho_2 L}{\text{tr}\{H_1^\dagger H_1 (I_L + \rho_1 H_1^\dagger H_1) H_2 H_2^\dagger\}}} \quad (54)$$

This scheme was shown to be asymptotically optimal when the number of relay nodes in the MIMO parallel relay channel approaches infinity [17]. When the number of relays are sufficiently large, the signals received by the destination will combine coherently, which yields a nice scaling law for the two-hop relay networks. However, the performance of this scheme was not shown in [17] when there exists a single relay, and thus we include this scheme for our comparison.

(3) Suboptimal Relaying (SOR): This scheme was proposed in [12]. The relay uses a weighting matrix:

$$F_{sor} = V_2 \Lambda_{F,sor} U_1^\dagger \quad (55)$$

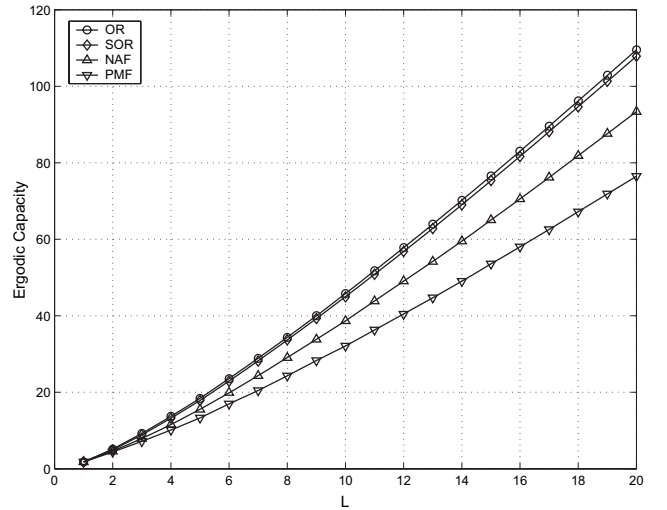

Fig. 5. Ergodic capacity  $E\{C_{I,B}\}$  as a function of  $L$  (the number of antennas at each terminal).  $\rho_1 = 10dB$ ,  $\rho_2 = 10dB$ .

where  $\Lambda_{F,sor} = \text{diag}\{f_{1,sor}, f_{2,sor}, \dots, f_{L,sor}\}$  with

$$f_{k,sor} = \sqrt{\frac{\rho_2 L}{1 + \rho_1 \alpha_k} \frac{|\frac{(\rho_2 + \phi_2)\alpha_k - \phi_1}{\phi_1 \beta_k}|}{\sum_{l=1}^L \frac{|\frac{(\rho_2 + \phi_2)\alpha_l - \phi_1}{\phi_1 \beta_l}|^2}}, \quad (56)$$

and  $\phi_1 = \frac{1}{L} \sum_{j=1}^L \alpha_j \beta_j^{-1}$  and  $\phi_2 = \frac{1}{L} \sum_{j=1}^L \beta_j^{-1}$ . This scheme was proved to be optimal when  $\rho_2$ , the signal to noise ratio at the destination, exceeds a (nonzero) threshold which depends on the eigenvalues of the channel matrices.

In the simulation, all channel matrices have i.i.d.  $\mathcal{CN}(0,1)$  entries. In order to include the suboptimal relaying scheme (which requires all channel matrices to be nonsingular) into the comparison, we also assume that all terminals are equipped with the same number of antennas  $L$ , i.e.  $M = N = L$ , although this is not required by other schemes.

Figure 3 shows the ergodic capacity of the relay channel as a function of  $\rho_1$ . Figure 4 shows the ergodic capacity of the relaying channel as a function of  $\rho_2$ . Figure 5 shows the ergodic capacity of the relay channel as a function of  $L$ , the

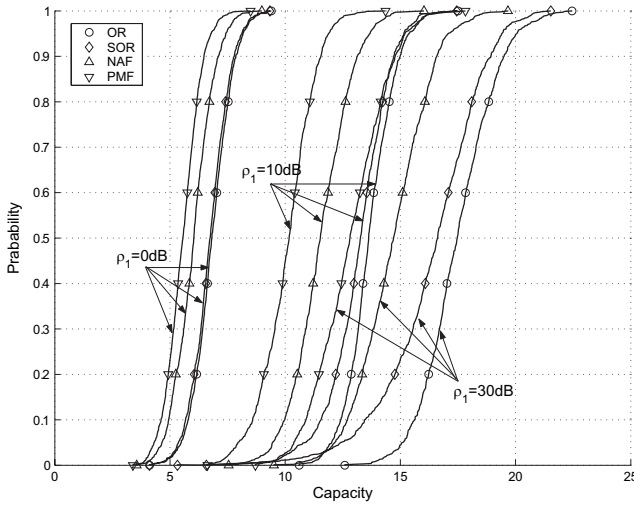

Fig. 6. Cumulative Distribution Functions (CDF) of the capacity  $C_{I,B}$  for different  $\rho_1$ .  $\rho_2 = 10dB$ .  $M = N = L = 4$ .

number of antennas at each terminal. It is clear that the Naive Amplify-and-Forward is far from the optimum. The Pseudo Match-and-Forward method is even worse than the Naive Amplify-and-Forward method, and therefore the weighting matrix given by (53) actually does not really “match” the channels.

Figure 6 shows the Cumulative Distribution Functions (CDF) of instantaneous capacity for different  $\rho_1$  when  $\rho_2$  is fixed to be  $10dB$ . Figure 7 shows the CDF of instantaneous capacity for different  $\rho_2$  when  $\rho_1$  is fixed to be  $10dB$ . It is clear that the capacity offered by the optimal relaying scheme is better than the suboptimal relaying. But both of the optimal and suboptimal schemes outperform the Naive Amplify-and-Forward and Pseudo Match-and-Forward methods. We can see that the capacities of the optimal and suboptimal schemes are very close when the signal to noise ratio at the destination is high, which is expected.

## VI. CAPACITY OF MIMO RELAY CHANNEL WITH DIRECT LINK

In sections III and IV, we discussed the optimal canonical coordinates and power allocation for orthogonal relay channel working in mode B: relaying without the direct link. In this section, we discuss the MIMO relay channel working in mode C: relaying with the direct link.

We have shown in section II that the relay channel working in mode C can be decomposed into two orthogonal channels working in mode A and mode B, respectively. The instantaneous channel capacity given by (9) can be further shown to be

$$C_{I,C} = \log_2 \left| I + \rho_0 H_0^\dagger H_0 \right| + \log_2 \left| I + \rho_1 H_3 H_3^\dagger \right| + \log_2 \frac{\left| \left( I + \rho_1 H_3 H_3^\dagger \right)^{-1} + G^\dagger H_2^\dagger H_2 G \right|}{\left| I + G^\dagger H_2^\dagger H_2 G \right|} \quad (57)$$

s.t.  $\text{tr}\{G(I + \rho_1 H_1 H_1^\dagger)G^\dagger\} \leq \rho_2 L$

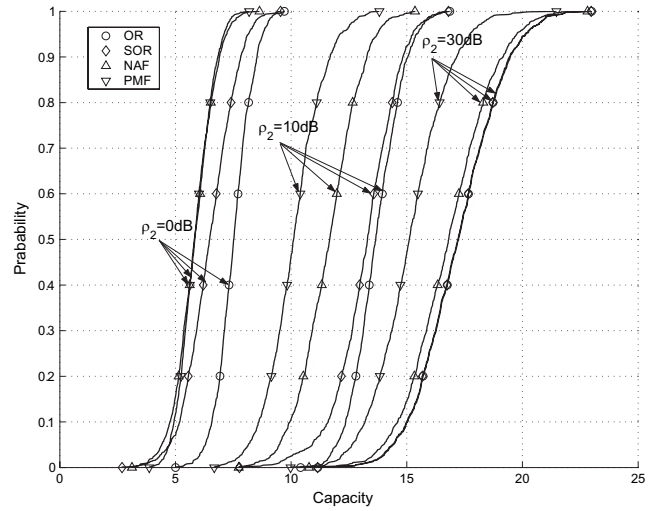

Fig. 7. Cumulative Distribution Functions (CDF) of the capacity  $C_{I,B}$  for different  $\rho_2$ .  $\rho_1 = 10dB$ .  $M = N = L = 4$ .

The first two terms are the combined capacity of the two (virtually parallel) channels represented by  $H_0$  and  $H_3$ . The channel  $H_3$  can be seen as a “projection” of  $H_1$  onto the channel  $H_0$  (see (10)). The third term can be regarded as the capacity loss (since it is always non-positive) due to the second hop (from the relay to the destination). We let the eigenvalue decomposition of  $H_3 H_3^\dagger$  be

$$H_3 H_3^\dagger = U_3 \Sigma_3 U_3^\dagger$$

where  $\Sigma_3 = \text{diag}\{\gamma_1, \gamma_2, \dots, \gamma_L\}$ .

We are unable to find the optimal right canonical coordinate for the weighting matrix  $F$  to optimize  $C_{I,C}$  (although the optimal left canonical coordinate seems still given by  $V_2$ ). It is easy to verify that  $U_1$  achieves the diagonalization of the power constraint, and  $U_3$  achieves the diagonalization of the cost  $C_{I,C}$ . But neither  $U_1$  nor  $U_3$  can achieve the desired diagonalization for both the cost function and the power constraint. Hence, it seems that the optimal right canonical coordinate  $U$  should be somewhere between  $U_1$  and  $U_3$ . Furthermore, even if we could find the optimal  $U$ , the cost function and the power constraint will not be diagonalized as that in mode B, and hence the optimal power allocation might not be tractable.

In order to get an idea of the optimal  $C_{I,C}$ , we now show an upper bound of the optimal  $C_{I,C}$  and two lower bounds of the optimal  $C_{I,C}$ .

### (1) Upper bound:

Using (10), it follows that

$$\begin{aligned} \text{tr}\{G(I + \rho_1 H_1 H_1^\dagger)G^\dagger\} &= \text{tr}\{G(I + \rho_1 H_3 H_3^\dagger)G^\dagger\} \\ &\quad + \rho_0 \rho_1 \text{tr}\{G H_3 H_0^\dagger H_0 H_3^\dagger G^\dagger\} \\ &\geq \text{tr}\{G(I + \rho_1 H_3 H_3^\dagger)G^\dagger\} \quad (58) \end{aligned}$$

Hence, an upper bound of  $C_{I,C}$  under the original power constraint is given by the maximum value of  $C_{I,C}$  under the following relaxed power constraint:

$$\text{tr}\{G(I + \rho_1 H_3 H_3^\dagger)G^\dagger\} \leq \rho_2 L. \quad (59)$$

Under the new power constraint, the optimization problem is the same as that in Sections III and IV. Hence, it follows

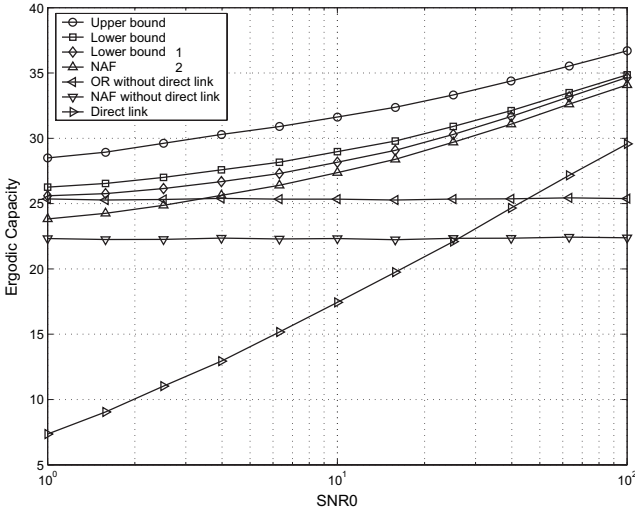

Fig. 8. Ergodic capacity  $E\{C_{I,C}\}$  as a function of  $\rho_0$ .  $\rho_1 = 20\text{dB}$ .  $\rho_2 = 20\text{dB}$ .  $M = 4$ ,  $N = 4$  and  $L = 4$ .

that the optimal relay matrix of  $C_{I,C}$  under (59) is given by  $F_c = V_2 \Lambda_{F,c} U_3^\dagger$  where  $\Lambda_{F,c} = \text{diag}\{f_{1,c}, f_{2,c}, \dots, f_{L,c}\}$  with

$$f_{k,c} = \frac{\sigma_2}{\sigma_1} \sqrt{\frac{1}{2\beta_k(1+\rho_1\gamma_k)}} \left[ \sqrt{\rho_1^2 \gamma_k^2 + 4\rho_1 \gamma_k \beta_k \mu_c^* - \rho_1 \gamma_k} - 2 \right]^+ \quad (60)$$

and  $\mu_c^*$  is the root of the following function

$$g_c(\mu) = \frac{1}{2} \sum_{k=1}^L \frac{1}{\beta_k} \left[ \sqrt{\rho_1^2 \gamma_k^2 + 4\rho_1 \gamma_k \beta_k \mu} - \rho_1 \gamma_k - 2 \right]^+ - \rho_2 L. \quad (61)$$

The expression of  $C_{I,C}$  with the relay matrix  $F_c$  is an upper bound of the optimal  $C_{I,C}$  under the original power constraint. (We will omit the detailed expressions of the bounds as they are easy to construct based on the discussions.)

### (2) Lower bound 1:

One lower bound of the optimal  $C_{I,C}$  is given by the expression of  $C_{I,C}$  with the relay matrix  $F$  derived for mode B as shown in Sections III and IV.

### (3) Lower bound 2:

Another lower bound of the optimal  $C_{I,C}$  is given by the expression of  $C_{I,C}$  with the relay matrix  $F'_c = \eta V_2 \Lambda_{F,c} U_3^\dagger$  where  $\eta$  is chosen to meet the original power constraint.

We now illustrate numerically the bounds of the optimal  $C_{I,C}$  along with the channel capacity using the Naive Amplify-and-Forward (NAF) relay matrix  $F_{naf}$  in mode C. All entries in  $H_0$ ,  $H_1$  and  $H_2$  were assumed to be *i.i.d.*  $\mathcal{CN}(0,1)$ . The number of antennas at the source, relay and destination is denoted by  $M, L$  and  $N$ , respectively.

Figure 8 shows the ergodic capacity  $E\{C_{I,C}\}$  as a function of  $\rho_0$  where  $\rho_1 = \rho_2 = 20\text{dB}$  and  $(M, L, N) = (4, 4, 4)$ . Both lower bounds of the optimal capacity are uniformly higher than the capacity provided by the NAF method. The CDF curves of  $C_{I,C}$  are shown in Figure 9.

## VII. CONCLUSIONS

In this paper, we have developed the optimal relay matrix for a non-regenerative MIMO relay system. This system

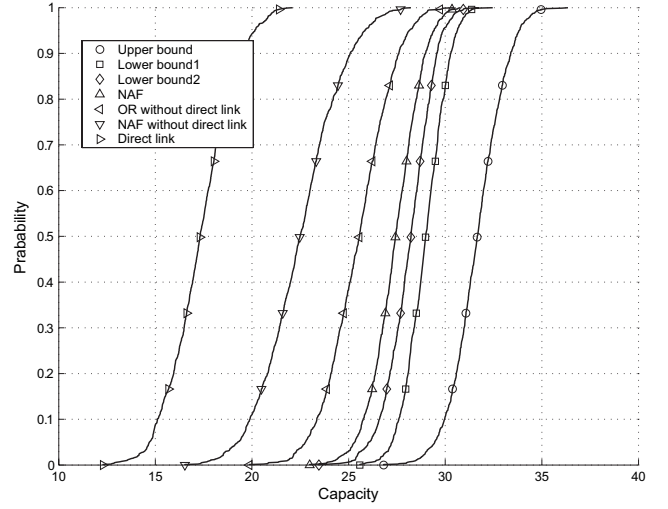

Fig. 9. Cumulative Distribution Functions (CDF) of  $C_{I,C}$ .  $\rho_0 = 10\text{dB}$ .  $\rho_1 = 20\text{dB}$ .  $\rho_2 = 20\text{dB}$ .  $M = 4$ ,  $N = 4$  and  $L = 4$ .

involves two hops: one is between the source and the relay, and the other is between the relay and the destination. The optimal relay matrix maximizes the capacity between the source and the destination in the absence of a direct link between the source and the destination. The optimal relay matrix obeys an optimal set of coordinates that transform the MIMO relay channel into a set of parallel SISO relay sub-channels. The optimal power allocation among the sub-channels has been found to follow a water-filling pattern. The optimal relay matrix yields a significantly larger capacity of the overall system than several other heuristic choices. We have also considered the case where there is a direct link between the source and the destination. But it seems untractable to obtain the optimal relay matrix in this case, and instead, we have provided an upper bound and two lower bounds on the optimal capacity. In this paper, we assumed that all symbols from the source antennas are independent and identically distributed. Future research could consider optimal coding at the source in the presence of a non-regenerative MIMO relay.

## APPENDIX I PROOF OF (5)

By applying the noise whitening matrix  $R^{-1/2}$  to both sides of (3), we have an equivalent system where the channel matrix is  $\tilde{H} = R^{-1/2} H_2 F H_1$  and the noise is white Gaussian. Therefore, the instantaneous capacity between the source and the destination is

$$\begin{aligned} C_{I,B} &= \log_2 \left| I + \frac{P_1}{M} \tilde{H}^\dagger \tilde{H} \right| \\ &= \log_2 \left| I + \frac{P_1}{M} (R^{-1/2} H_2 F H_1)^\dagger (R^{-1/2} H_2 F H_1) \right| \\ &= \log_2 \left| I + \frac{P_1}{M} H_1^\dagger (H_2 F)^\dagger R^{-1} (H_2 F) H_1 \right|. \end{aligned}$$

Note that we have ignored the constant factor 1/2 that accounts for the two orthogonal channels used between the source and the destination. Clearly, this constant has no effect on the optimal choice of the relay matrix  $F$ . Such a factor will be



$$\begin{aligned}
C_{I,B} &= \log_2 \left| I + \frac{P_1}{M\sigma_1^2} H_1^\dagger \underbrace{\left( \frac{\sigma_1}{\sigma_2} H_2 F \right)^\dagger \left( I_N + \left( \frac{\sigma_1}{\sigma_2} H_2 F \right) \left( \frac{\sigma_1}{\sigma_2} H_2 F \right)^\dagger \right)^{-1}}_{\left( \frac{\sigma_1}{\sigma_2} H_2 F \right) H_1} \right| \\
&= \log_2 \left| I + \frac{P_1}{M\sigma_1^2} H_1^\dagger \left( I_L - \underbrace{\left( I_L + \left( \frac{\sigma_1}{\sigma_2} H_2 F \right)^\dagger \left( \frac{\sigma_1}{\sigma_2} H_2 F \right) \right)^{-1}}_{\left( \frac{\sigma_1}{\sigma_2} H_2 F \right) H_1} \right) H_1 \right| \quad (62)
\end{aligned}$$

ignored for all other cases. Using (4), we have (62), which can be seen at the top of the page.

where the underbraced terms are equal, which can be verified by applying the matrix inverse lemma or a straightforward proof. We let  $\rho_1 = \frac{P_1}{M\sigma_1^2}$  and  $S = I_L + \frac{\sigma_1^2}{\sigma_2^2} F^\dagger H_2^\dagger H_2 F$ . Then,

$$C_{I,B} = \log_2 \left| I_L + \rho_1 H_1 H_1^\dagger - \rho_1 H_1 H_1^\dagger S^{-1} \right|$$

where we applied the property that  $|I + AB| = |I + BA|$  if  $AB$  is complex conjugate symmetric.

## APPENDIX II PROOF OF (8) AND (9)

The covariance matrix of the noise term in (7) is

$$R_2 = \begin{pmatrix} \sigma_0^2 I_N & O \\ O & R \end{pmatrix}$$

where  $R$  is given by (4). Applying the noise whitening matrix, we have an equivalent system where the noise is white Gaussian and the channel matrix is

$$\hat{H} = \begin{pmatrix} \sigma_0^{-1} H_0 \\ \tilde{H} \end{pmatrix}$$

and  $\tilde{H}$  is given in Appendix I. Hence, the instantaneous capacity between the source and the destination is

$$\begin{aligned}
C_{I,C} &= \log_2 \left| I + \frac{P_1}{M} \hat{H}^\dagger \hat{H} \right| \\
&= \log_2 \left| I + \frac{P_1}{M} \left( \sigma_0^{-2} H_0^\dagger H_0 + \tilde{H}^\dagger \tilde{H} \right) \right| \\
&= \log_2 \left| I + \rho_0 H_0^\dagger H_0 + \frac{P_1}{M} \tilde{H}^\dagger \tilde{H} \right| \\
&= \log_2 \left| I_M + \rho_0 H_0^\dagger H_0 + \rho_1 H_1^\dagger H_1 - \rho_1 H_1^\dagger S^{-1} H_1 \right|
\end{aligned}$$

where  $\rho_0 = \frac{P_1}{M\sigma_0^2}$ . Define  $H_3 = H_1 \left( I_M + \rho_0 H_0^\dagger H_0 \right)^{-1/2}$ . Then,  $C_{I,C}$  can be further written as

$$\begin{aligned}
C_{I,C} &= \log_2 \left| \left( I_M + \rho_0 H_0^\dagger H_0 \right) \left( I_M + \rho_1 H_3^\dagger H_3 - \rho_1 H_3^\dagger S^{-1} H_3 \right) \right| \\
&= \log_2 \left| I_M + \rho_0 H_0^\dagger H_0 \right| + \log_2 \left| I_M + \rho_1 H_3^\dagger H_3 - \rho_1 H_3^\dagger S^{-1} H_3 \right| \\
&= \log_2 \left| I_M + \rho_0 H_0^\dagger H_0 \right| + \log_2 \left| I_L + \rho_1 H_3 H_3^\dagger - \rho_1 H_3 H_3^\dagger S^{-1} \right|.
\end{aligned}$$

## REFERENCES

- [1] E. C. Van Der Meulen, "Three terminal communication channels," *Adv. Appl. Prob.*, vol. 3, pp. 120–154, 1971.
- [2] T. M. Cover and A. A. El Gamal, "Capacity theorems for the relay channel," *IEEE Trans. Inf. Theory*, vol. 25, no. 5, pp. 572–584, Sept. 1979.
- [3] A. Sendonaris, E. Erkip, and B. Aazhang, "User cooperation diversity—part I and part II," *IEEE Trans. Commun.*, vol. 51, no. 11, pp. 1927–1948, Nov. 2003.
- [4] M. A. Khojastepur and B. Aazhang, "Cheap relay channel: a unifying approach to time and frequency division relaying," in *Proc. Annual Allerton Conference on Communication, Control and Computing 2004*.
- [5] R. U. Nabar, H. Bolcskei, and F. W. Kneubuhler, "Fading relay channels: performance limits and space-time signal design," *IEEE J. Sel. Areas Commun.*, vol. 22, no. 6, pp. 1099–1109, Aug. 2004.
- [6] J. N. Laneman, D. N. C. Tse, and G. W. Wornell, "Cooperative diversity in wireless networks: efficient protocols and outage behavior," *IEEE Trans. Inf. Theory*, vol. 50, no. 12, pp. 3062–3080, Dec. 2004.
- [7] A. Host-Madsen and J. Zhang, "Capacity bounds and power allocation for wireless relay channel," *IEEE Trans. Inf. Theory*, vol. 51, no. 6, pp. 2020–2040, June 2005.
- [8] E. Telatar, "Capacity of multi-antenna gaussian channels," Technical Report, Bell Labs, 1995.
- [9] G. J. Foschini and M. J. Gans, "On limits of wireless communications in a fading environment when using multiple antennas," *Wireless Personal Commun.*, vol. 6, pp. 311–335, March 1998.
- [10] B. Wang, J. Zhang, and A. Host-Madsen, "On the capacity of MIMO relay channels," *IEEE Trans. Inf. Theory*, vol. 51, no. 1, pp. 29–43, Jan. 2005.
- [11] N. Laneman, *Cooperative Diversity in Wireless Networks: Algorithms and Architectures*, Ph.D. dissertation, MIT, Cambridge, MA, Aug. 2002.
- [12] X. Tang and Y. Hua, "Optimal waveform design for MIMO relaying," in *Proc. IEEE Workshop on Signal Processing Advances in Wireless Communications 2005*.
- [13] O. Munoz, J. Vidal, and A. Agustin, "Non-regenerative MIMO relaying with channel state information," in *Proc. IEEE ICASSP 2005*.
- [14] R. A. Horn and C. R. Johnson, *Matrix Analysis*. Cambridge University Press, 1985.
- [15] S. Boyd and L. Vandenberghe, *Convex Optimization*. Cambridge University Press, 2004.
- [16] T. M. Cover and J. A. Thomas, *Elements of Information Theory*. New York: Wiley, 1991.
- [17] P. U. Sripathi and J. S. Lehnert, "A throughput scaling law for a class of wireless relay networks," in *Proc. 38th Annual Asilomar Conference on Signals, Systems and Computers 2004*.



**Xiaojun Tang** received the B.S. and M.S. degrees in electrical engineering from University of Electronic Science and Technology of China, Chengdu, China, in 2000 and 2003, respectively. During 2003–2005, he was a Ph.D. student at the University of California, Riverside, CA, with Prof. Y. Hua working in the area of wireless communication and networking. In 2005, for family reason, he moved to the east coast of the US to the Wireless Information Network Laboratory, Rutgers University, NJ, where he is currently working toward the Ph.D. degree.



**Yingbo Hua** (S'86-M'88-SM'92-F'02) received a B.S. degree from Nanjing Institute of Technology (Southeast University), Nanjing, China, in 1982, and a Ph.D. degree from Syracuse University, Syracuse, NY, in 1988, with support of a Chinese Government Scholarship and a Syracuse University Graduate Fellowship. He was a research fellow at Syracuse during 1988-1989, also consulting for Aeritalia, Italy, and Syracuse Research, NY. In February 1990, he joined the faculty of the University of Melbourne, Australia, where he was a professor until April 2001.

He spent his sabbatical leave with Hong Kong University of Science and Technology from 1999 to 2000, and Microsoft Research, WA, in Summer 2000. Since February 2001, he has been a Professor of Electrical Engineering with the University of California at Riverside. Professor Hua has guided 20 Ph.D. students, 7 masters-by-research students, and 11 postdoctoral fellows. He has published over 260 research articles in the field of signal processing

and its applications. He is a co-editor of the books: *Signal Processing Advances in Wireless and Mobile Communications*, (Prentice-Hall, 2001), and *High-Resolution and Robust Signal Processing*, (Marcel Dekker, 2003). He has served as Associate Editor for *IEEE Transactions on Signal Processing* (1994-1997, 2001-2002) and *IEEE Signal Processing Letters* (1998-2002), and Guest Editor for *IEEE Signal Processing Magazine* (2005-2006). He has been on the Editorial Boards of *EURASIP Signal Processing* since 2005 and *IEEE Signal Processing Magazine* since 2007. He has served as an elected member on IEEE Signal Processing Society's Technical Committees on Underwater Acoustic Signal Processing, Sensor Array and Multi-channel Processing, and Signal Processing for Communications. He currently serves as the chair of the Executive Committee for Communications and Networking under the University of California's Industry and University Cooperative Research Program. His recent research activities focus on signal processing for wireless networking.